

Features

- 400mW Power Dissipation on FR-4 PCB
- Very Tight Tolerance on Vz
- Ideally Suited for Automated Assembly Processes
- **Totally Lead-Free & Fully RoHS Compliant (Notes 1 & 2)**
- **Halogen and Antimony Free. "Green" Device (Note 3)**

Mechanical Data

- Case: SOD323F
- Case Material: Molded Plastic, "Green" Molding Compound; UL Flammability Classification Rating 94V-0
- Moisture Sensitivity: Level 1 per J-STD-020
- Terminal Connections: Cathode Band
- Terminals: Finish - Matte Tin Annealed over Copper Alloy leadframe. Solderable per MIL-STD-202, Method 208 [Ⓔ]
- Weight: 0.01 grams (Approximate)

SOD323F

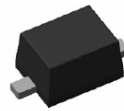

Top View

Ordering Information (Note 4)

| Part Number (Type Number)-7* | Case SOD323F | Packaging 3,000/Tape & Reel |
|---------------------------------|-----------------|--------------------------------|
| | | |

* Example: The part number for the 3.6 Volt device would be D3Z3V6BF-7.

- Notes:
1. No purposely added lead. Fully EU Directive 2002/95/EC (RoHS) & 2011/65/EU (RoHS 2) compliant.
 2. See http://www.diodes.com/quality/lead_free.html for more information about Diodes Incorporated's definitions of Halogen- and Antimony-free, "Green" and Lead-free.
 3. Halogen- and Antimony-free "Green" products are defined as those which contain <900ppm bromine, <900ppm chlorine (<1500ppm total Br + Cl) and <1000ppm antimony compounds.
 4. For packaging details, go to our website at <http://www.diodes.com/products/packages.html>.

Marking Information



XX = Product Type Marking Code
(See Electrical Characteristics Table)
YM = Date Code Marking
Y = Year (ex: X = 2010)
M = Month (ex: 9 = September)

Date Code Key

| Year | 2010 | 2011 | 2012 | 2013 | 2014 | 2015 | 2016 | 2017 | 2018 | 2019 | 2020 | |
|-------|------|------|------|------|------|------|------|------|------|------|------|-----|
| Code | X | Y | Z | A | B | C | D | E | F | G | H | |
| Month | Jan | Feb | Mar | Apr | May | Jun | Jul | Aug | Sep | Oct | Nov | Dec |
| Code | 1 | 2 | 3 | 4 | 5 | 6 | 7 | 8 | 9 | O | N | D |

Maximum Ratings (@T_A = +25°C, unless otherwise specified.)

| Characteristic | Symbol | Value | Unit |
|-----------------|----------------|-------|------|
| Forward Voltage | V _F | 0.9 | V |

Thermal Characteristics

| Characteristic | Symbol | Value | Unit |
|--|-----------------------------------|-------------|------|
| Power Dissipation (Note 5) | P _D | 400 | mW |
| Thermal Resistance, Junction to Ambient Air (Note 5) | R _{θJA} | 312.5 | °C/W |
| Operating and Storage Temperature Range | T _J , T _{STG} | -65 to +150 | °C |

Electrical Characteristics (@T_A = +25°C, unless otherwise specified.)

| Type Number | Marking Code | Zener Voltage Range (Note 6) | | | Maximum Zener Impedance f = 1kHz | | | Maximum Reverse Current (Note 7) | | Typical Temperature Coefficient | Typical Total Capacitance |
|-------------|--------------|----------------------------------|---------|-----------------|-----------------------------------|-----------------------------------|-----------------|----------------------------------|------------------|---------------------------------|---------------------------------|
| | | V _Z @ I _{ZT} | | I _{ZT} | Z _{ZT} @ I _{ZT} | Z _{ZK} @ I _{ZK} | I _{ZK} | I _R | @ V _R | @ I _{ZT} = 5mA | @ V _R = 0V, f = 1MHz |
| | | Min (V) | Max (V) | mA | Ω | | mA | μA | V | mV/°C | pF |
| D3Z2V4BF | L0 | 2.43 | 2.63 | 5 | 100 | 1000 | 0.5 | 50 | 1 | -1.6 | 215 |
| D3Z2V7BF | L1 | 2.69 | 2.91 | 5 | 100 | 1000 | 0.5 | 20 | 1 | -1.7 | 205 |
| D3Z3V0BF | L2 | 2.85 | 3.07 | 5 | 95 | 1000 | 0.5 | 10 | 1 | -1.7 | 195 |
| D3Z3V3BF | L3 | 3.32 | 3.53 | 5 | 95 | 1000 | 0.5 | 5 | 1 | -1.9 | 145 |
| D3Z3V6BF | L4 | 3.60 | 3.85 | 5 | 90 | 500 | 1.0 | 5 | 1 | -2.4 | 185 |
| D3Z3V9BF | L5 | 3.89 | 4.16 | 5 | 90 | 500 | 1.0 | 3 | 1 | -2.5 | 175 |
| D3Z4V3BF | L6 | 4.17 | 4.48 | 5 | 90 | 600 | 1.0 | 3 | 1 | -2.5 | 165 |
| D3Z4V7BF | L7 | 4.55 | 4.75 | 5 | 90 | 600 | 1.0 | 2 | 1 | -1.1 | 150 |
| D3Z5V1BF | GM, L8 | 4.96 | 5.20 | 5 | 60 | 250 | 0.5 | 2 | 1.5 | 0.3 | 145 |
| D3Z5V6BF | L9 | 5.48 | 5.73 | 5 | 50 | 100 | 0.5 | 1 | 2.5 | 1.7 | 20 |
| D3Z6V2BF | LA | 6.06 | 6.33 | 5 | 50 | 80 | 0.5 | 0.5 | 3 | 2.5 | 95 |
| D3Z6V8BF | LB | 6.65 | 6.93 | 5 | 40 | 60 | 0.5 | 0.5 | 3.5 | 3.4 | 82 |
| D3Z7V5BF | LC | 7.28 | 7.60 | 5 | 10 | 60 | 0.5 | 0.5 | 4 | 4.0 | 70 |
| D3Z8V2BF | LD | 8.02 | 8.36 | 5 | 10 | 60 | 0.5 | 0.5 | 5 | 4.6 | 57 |
| D3Z9V1BF | LE | 8.85 | 9.23 | 5 | 10 | 60 | 0.5 | 0.5 | 6 | 5.0 | 50 |
| D3Z10BF | LF | 9.77 | 10.21 | 5 | 10 | 60 | 0.5 | 0.1 | 7 | 6.1 | 45 |
| D3Z11BF | LG | 10.78 | 11.22 | 5 | 10 | 60 | 0.5 | 0.1 | 8 | 7.4 | 41 |
| D3Z12BF | LH | 11.74 | 12.24 | 5 | 10 | 80 | 0.5 | 0.1 | 9 | 8.2 | 36 |
| D3Z13BF | LJ | 12.91 | 13.49 | 5 | 10 | 80 | 0.5 | 0.1 | 10 | 9.4 | 33 |
| D3Z15BF | LK | 14.34 | 14.98 | 5 | 15 | 80 | 0.5 | 0.05 | 11 | 12.1 | 28 |
| D3Z16BF | LL | 15.85 | 16.51 | 5 | 20 | 80 | 0.5 | 0.05 | 12 | 13.7 | 25 |
| D3Z18BF | LM | 17.56 | 18.35 | 5 | 20 | 80 | 0.5 | 0.05 | 13 | 15.8 | 24 |
| D3Z20BF | LN | 19.52 | 20.39 | 5 | 20 | 100 | 0.5 | 0.05 | 15 | 16.4 | 22 |
| D3Z22BF | LP | 21.54 | 22.47 | 5 | 25 | 100 | 0.5 | 0.05 | 17 | 18.4 | 20 |
| D3Z24BF | LQ | 23.72 | 24.78 | 5 | 30 | 120 | 0.5 | 0.05 | 19 | 20.4 | 18 |
| D3Z27BF | LR | 26.19 | 27.53 | 5 | 40 | 150 | 0.5 | 0.05 | 21 | 18.0 | 17 |
| D3Z30BF | LS | 29.19 | 30.69 | 5 | 40 | 200 | 0.5 | 0.05 | 23 | 28.6 | 17 |
| D3Z33BF | LT | 32.15 | 33.79 | 5 | 40 | 250 | 0.5 | 0.05 | 25 | 32.2 | 15 |
| D3Z36BF | LU | 35.07 | 36.87 | 5 | 60 | 300 | 0.5 | 0.05 | 27 | 34.9 | 14 |

- Notes:
5. Device mounted on FR-4 PCB with suggested pad layout, board size 35mm * 25mm.
 6. The Zener voltage is measured <40ms after power is supplied.
 7. Short duration pulse test used to minimize self-heating effect.

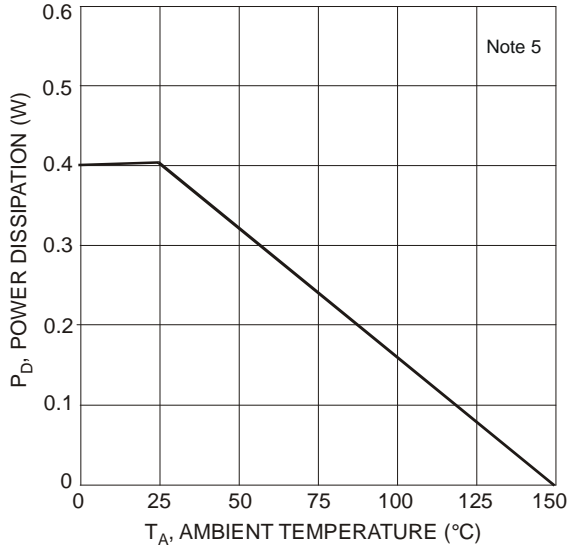

Fig. 1 Power Derating Curve

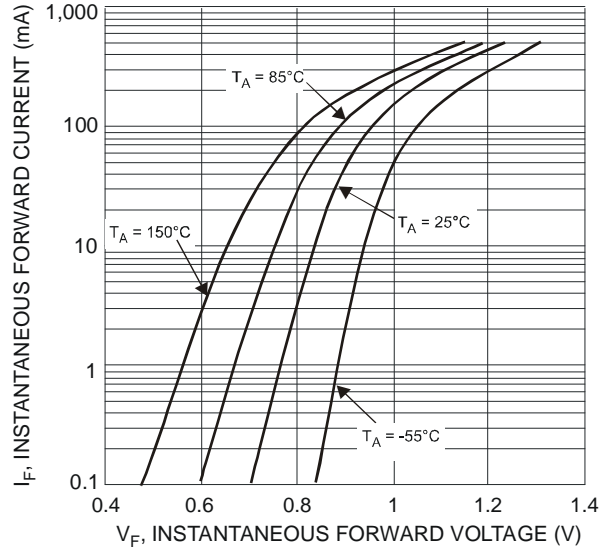

Fig. 2 Typical Forward Characteristics

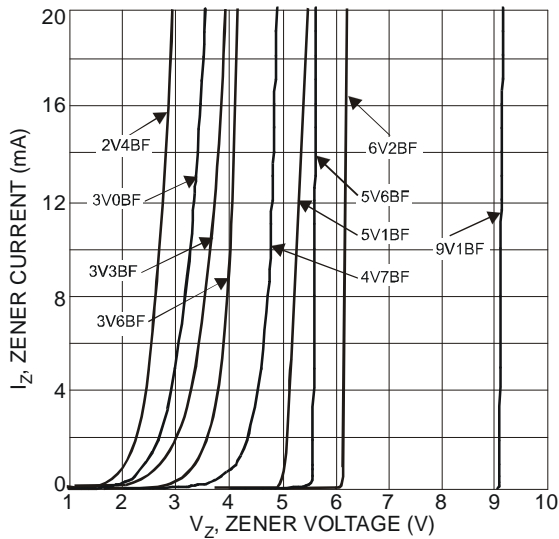

Fig. 3 Typical Zener Breakdown Characteristics

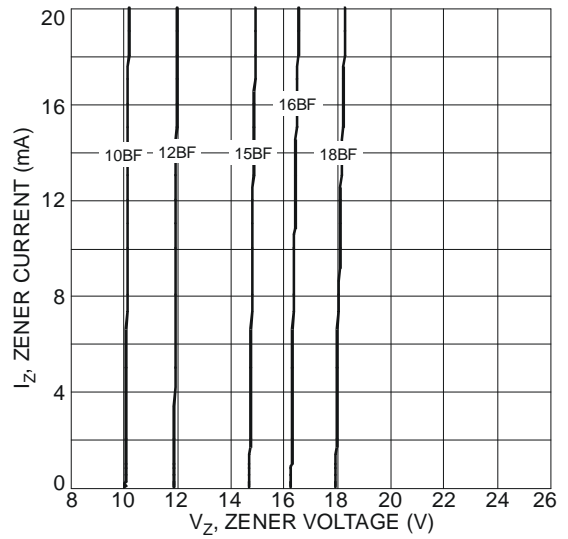

Fig. 4 Typical Zener Breakdown Characteristics

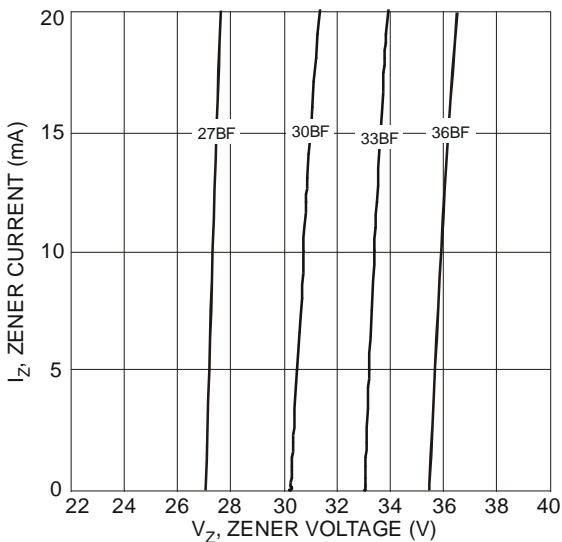
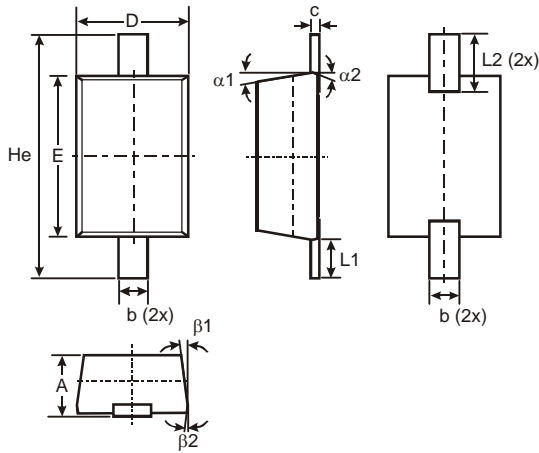

Fig. 5 Typical Zener Breakdown Characteristics

Package Outline Dimensions

Please see AP02001 at http://www.diodes.com/_files/datasheets/ap02001.pdf for the latest version.

SOD323F



| SOD323F | | | |
|----------------------|------|------|------|
| Dim | Min | Max | Typ |
| A | 0.60 | 0.75 | – |
| b | 0.25 | 0.35 | – |
| c | 0.05 | 0.26 | – |
| D | 1.15 | 1.35 | 1.25 |
| E | 1.60 | 1.80 | 1.70 |
| He | 2.30 | 2.70 | 2.50 |
| L1 | 0.30 | 0.50 | 0.40 |
| L2 | 0.41 | 0.61 | 0.51 |
| α1 | – | – | 7° |
| α2 | – | – | 3° |
| β1 | – | – | 7° |
| β2 | – | – | 3° |
| All Dimensions in mm | | | |

Suggested Pad Layout

Please see AP02001 at http://www.diodes.com/_files/datasheets/ap02001.pdf for the latest version.

SOD323F

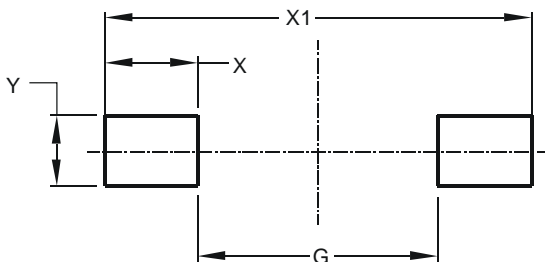

| Dimensions | Value (in mm) |
|------------|---------------|
| G | 1.280 |
| X | 0.710 |
| X1 | 2.700 |
| Y | 0.403 |

IMPORTANT NOTICE

DIODES INCORPORATED MAKES NO WARRANTY OF ANY KIND, EXPRESS OR IMPLIED, WITH REGARDS TO THIS DOCUMENT, INCLUDING, BUT NOT LIMITED TO, THE IMPLIED WARRANTIES OF MERCHANTABILITY AND FITNESS FOR A PARTICULAR PURPOSE (AND THEIR EQUIVALENTS UNDER THE LAWS OF ANY JURISDICTION).

Diodes Incorporated and its subsidiaries reserve the right to make modifications, enhancements, improvements, corrections or other changes without further notice to this document and any product described herein. Diodes Incorporated does not assume any liability arising out of the application or use of this document or any product described herein; neither does Diodes Incorporated convey any license under its patent or trademark rights, nor the rights of others. Any Customer or user of this document or products described herein in such applications shall assume all risks of such use and will agree to hold Diodes Incorporated and all the companies whose products are represented on Diodes Incorporated website, harmless against all damages.

Diodes Incorporated does not warrant or accept any liability whatsoever in respect of any products purchased through unauthorized sales channel. Should Customers purchase or use Diodes Incorporated products for any unintended or unauthorized application, Customers shall indemnify and hold Diodes Incorporated and its representatives harmless against all claims, damages, expenses, and attorney fees arising out of, directly or indirectly, any claim of personal injury or death associated with such unintended or unauthorized application.

Products described herein may be covered by one or more United States, international or foreign patents pending. Product names and markings noted herein may also be covered by one or more United States, international or foreign trademarks.

This document is written in English but may be translated into multiple languages for reference. Only the English version of this document is the final and determinative format released by Diodes Incorporated.

LIFE SUPPORT

Diodes Incorporated products are specifically not authorized for use as critical components in life support devices or systems without the express written approval of the Chief Executive Officer of Diodes Incorporated. As used herein:

A. Life support devices or systems are devices or systems which:

1. are intended to implant into the body, or
2. support or sustain life and whose failure to perform when properly used in accordance with instructions for use provided in the labeling can be reasonably expected to result in significant injury to the user.

B. A critical component is any component in a life support device or system whose failure to perform can be reasonably expected to cause the failure of the life support device or to affect its safety or effectiveness.

Customers represent that they have all necessary expertise in the safety and regulatory ramifications of their life support devices or systems, and acknowledge and agree that they are solely responsible for all legal, regulatory and safety-related requirements concerning their products and any use of Diodes Incorporated products in such safety-critical, life support devices or systems, notwithstanding any devices- or systems-related information or support that may be provided by Diodes Incorporated. Further, Customers must fully indemnify Diodes Incorporated and its representatives against any damages arising out of the use of Diodes Incorporated products in such safety-critical, life support devices or systems.

Copyright © 2016, Diodes Incorporated

www.diodes.com